

Midterm 2

Math 3C: Precalculus
Instructor: David Lenz
November 21, 2019

Name: Solutions PID: _____

Seat Number: _____

Do not begin this exam until instructed to do so.

When the exam begins, **FIRST** write your name and PID at the top of each page. **Pages without a name may not be graded.**

There are 8 problems on this exam. You must show the steps you took to arrive at your answer in order to receive full points (unless explicitly stated otherwise). If you need more space for your answer than is provided, write a clear statement that your answer continues on a separate page. Then, using an empty sheet of scratch paper, continue your answer and submit this sheet with your exam. You must tell the TA that you have extra pages when you turn in your exam. If you need to repeat this process for multiple questions, use a separate sheet for each question.

The use of calculators and formula sheets (“cheat sheets”) is prohibited on this exam. All phones and similar electronic devices, as well as notes and notebooks must be put away in a closed bag or likewise out of sight.

At the end of the exam, bring your student ID and exam to the front of the hall to be collected.

NAME:

PID:

Midterm 2

Problem 1 Let $f(x) = 2 \cdot 3 \cdot 3^{x+2}$, and $g(x) = 3 \cdot 3^x$. Describe $f(x)$ in terms of transformations of $g(x)$. (i.e. " $f(x)$ is the same as $g(x)$ shifted/stretched/reflected vertically/horizontally by...")

$f(x)$ is the same as $g(x)$ shifted left by 2 units and stretched vertically by a factor of 2.

Sketch $f(x)$ and $g(x)$ on the same set of axes. Your graph does not need to be precise but should accurately represent the locations of any intercepts and asymptotes.

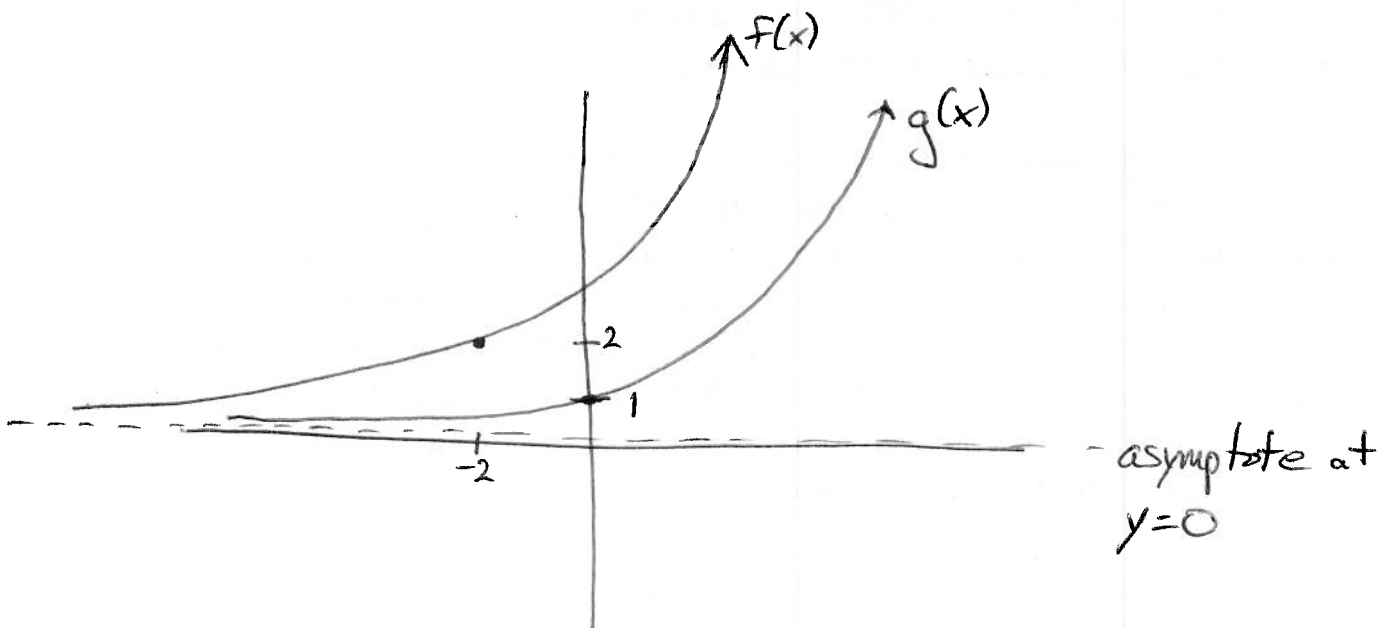

Problem 2 In the diagram below, the circle shown has radius 4. In addition, $\cos(\theta) = -\frac{\sqrt{3}}{2}$ and $\sin(\theta) = \frac{1}{2}$, where θ is the angle shown.

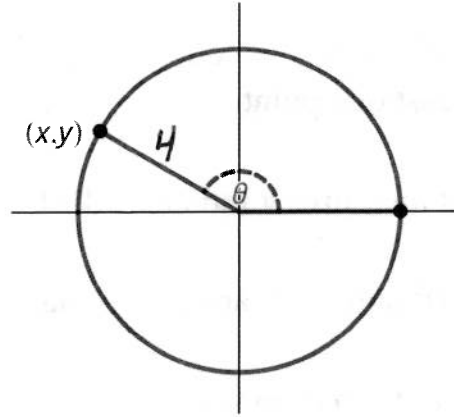

What are the values of x and y ?

$$x = r \cdot \cos(\theta) = 4 \cdot \cos(\theta) = 4 \cdot \left(-\frac{\sqrt{3}}{2}\right) = -2\sqrt{3}$$

$$y = r \cdot \sin(\theta) = 4 \cdot \sin(\theta) = 4 \cdot \frac{1}{2} = 2$$

The measure of θ is 150° . What is the measure of θ in radians?

$$\frac{150}{360} \cdot 2\pi = \frac{15}{36} \cdot 2\pi = \frac{5}{12} \cdot 2\pi = \frac{10\pi}{12} = \frac{5\pi}{6}$$

What is the length of the arc spanned by angle θ ?

$$\text{arclength} = \frac{150}{360} \cdot \text{circumference}$$

$$= \frac{5}{12} \cdot 2\pi r = \frac{5}{12} \cdot 2 \cdot \pi \cdot 4 = \frac{40\pi}{12} = \frac{10\pi}{3}$$

Problem 3 True or False. Write the word “True” or “False” next to each statement. You *do not* need to show your work for this question.

True

The circle defined by the equation $(x - 2)^2 + y^2 = 9$ intersects the y -axis at at least one point.

True

An angle that measures π radians is 180° when measured in degrees.

False

The angles 60° and -60° are coterminal.

True

$g(y) = 3 - 3x^2$ is an even function.

True

The function $b(s) = (0.9)^s$ is decreasing.

False

The range of $w(z) = \log_{10}(z)$ is all $z > 0$.

False

The leading term of $p(x) = 2x^2 + x^3 + 1$ is $2x^2$.

False

The polynomial $q(b) = -4(b - 3)^2(b - 2)^3$ has a root at $b = 3$, and the multiplicity of that root is 1.

Problem 4 Solve the equation $\log_2(y+3) = \log_2(y) + \log_2(3)$ for y .

$$\log_2(y+3) = \log_2(y) + \log_2(3)$$

$$\Rightarrow \log_2(y+3) = \log_2(y \cdot 3)$$

one possible
solution

another solution

Since $\log_2(x)$ is one-to-one,
this means that

$$y+3 = y \cdot 3$$

$$\Rightarrow 3 = 3y - y$$

$$\Rightarrow 3 = 2y$$

$$\Rightarrow y = \frac{3}{2}$$

$$\Rightarrow \log_2(y+3) - \log_2(3y) = 0$$

$$\Rightarrow \log_2\left(\frac{y+3}{3y}\right) = 0$$

$$\Rightarrow 2^0 = \frac{y+3}{3y}$$

$$\Rightarrow 1 = \frac{y+3}{3y}$$

$$\Rightarrow 3y = y+3$$

$$\Rightarrow 2y = 3$$

$$\Rightarrow y = \frac{3}{2}$$

Problem 5 Let $p(x) = -\frac{1}{2}(x-1)^4(x-2)^2$.

What are the horizontal intercepts of $p(x)$?

$$x=1 \quad \text{and} \quad x=2 \quad \text{i.e.} \quad \boxed{(1,0) \text{ and } (2,0)}$$

What are the multiplicities of each root of $p(x)$?

$$4 \quad \text{and} \quad 2, \text{ respectively}$$

What is the vertical intercept of $p(x)$?

$$p(0) = -\frac{1}{2}(0-1)^4(0-2)^2 = -\frac{1}{2} \cdot (-1)^4 \cdot (-2)^2 = -\frac{1}{2} \cdot 1 \cdot 4 = -2 \rightarrow \boxed{(0,-2)}$$

What is the long-run behavior of $p(x)$?

$$\text{As } x \rightarrow \infty, p(x) \rightarrow -\infty$$

$$\text{As } x \rightarrow -\infty, p(x) \rightarrow -\infty$$

Sketch a general graph of $p(x)$, labeling all intercepts.

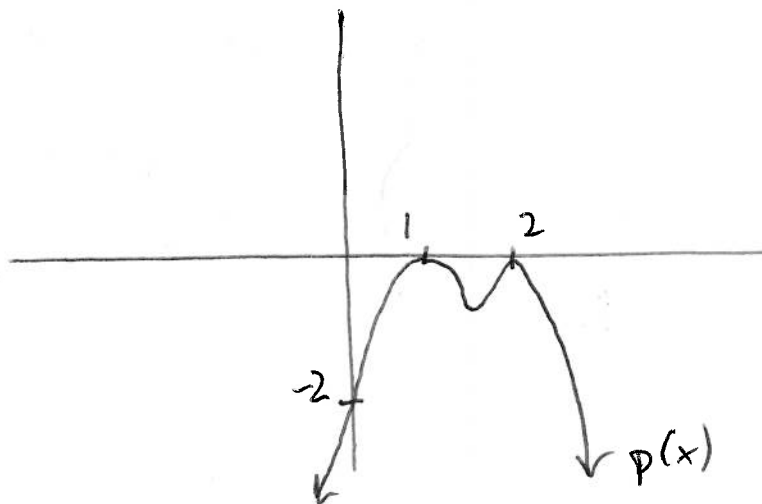

Problem 6 Consider the line $y = 3$ and the circle $(x + 2)^2 + (y - 2)^2 = 4$. Sketch both the line and the circle on the axes below.

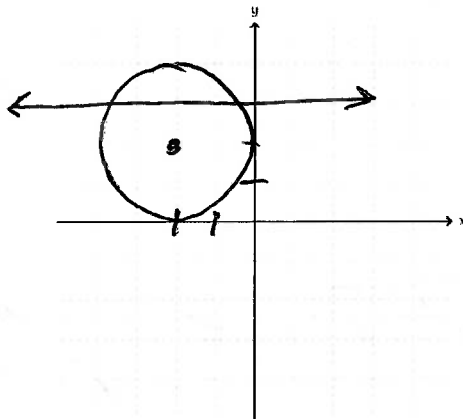

At what point(s) do the line and the circle intersect? Solve for these points algebraically, and write your answer(s) as a coordinate pair. (you may want to use the quadratic equation at some point in your solution)

$$(x+2)^2 + (y-2)^2 = 4 \quad y = 3$$

← substitute

$$(x+2)^2 + (3-2)^2 = 4$$

$$\Rightarrow x^2 + 4x + 4 + 1 = 4$$

$$\Rightarrow x^2 + 4x + 1 = 0$$

$$\Rightarrow x = \frac{-4 \pm \sqrt{4^2 - 4(1)(1)}}{2 \cdot 1}$$

$$= \frac{-4 \pm \sqrt{16 - 4}}{2}$$

$$= \frac{-4 \pm \sqrt{12}}{2}$$

$$= -2 \pm \frac{\sqrt{12}}{2}$$

Optional simplification: $= -2 \pm \frac{2\sqrt{3}}{2} = -2 \pm \sqrt{3}$

Intersection at

$$\left(-2 + \frac{\sqrt{12}}{2}, 3 \right) \text{ and } \left(-2 - \frac{\sqrt{12}}{2}, 3 \right)$$

Problem 7 Match each graph to its corresponding equation. Next to each equation, write the letter of the graph it matches. *(double check your work! No partial credit)*

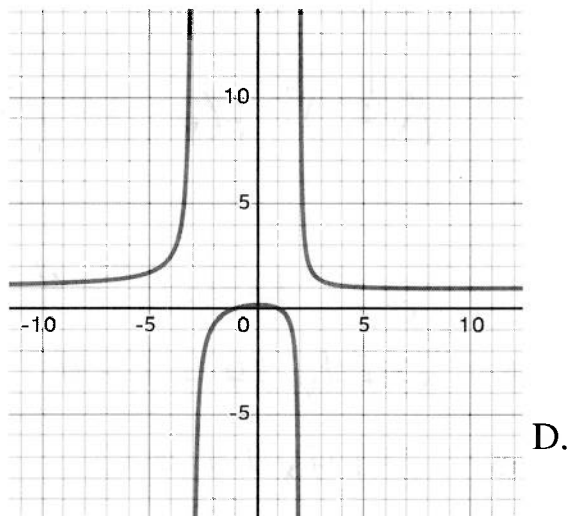
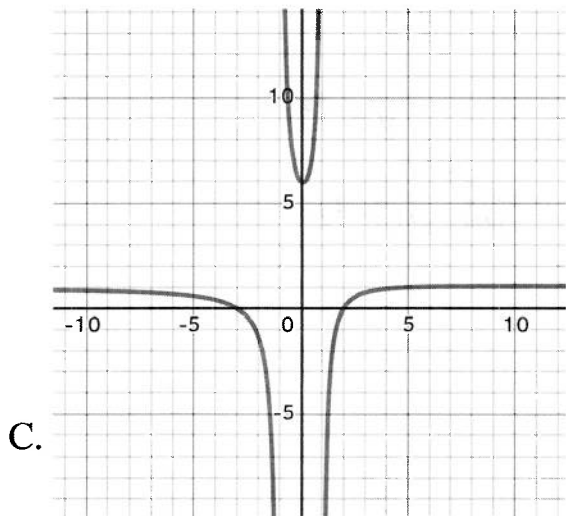
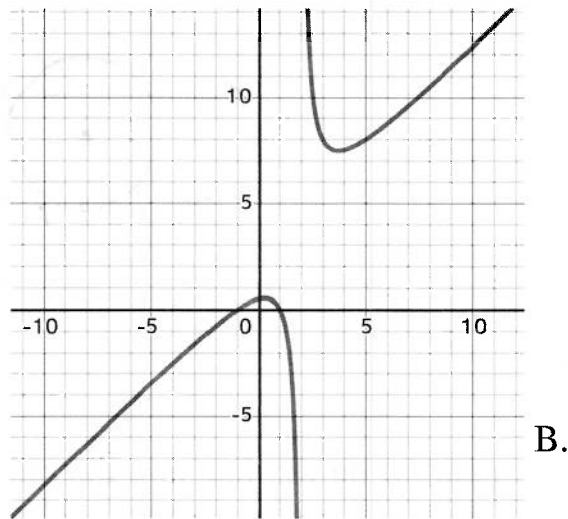
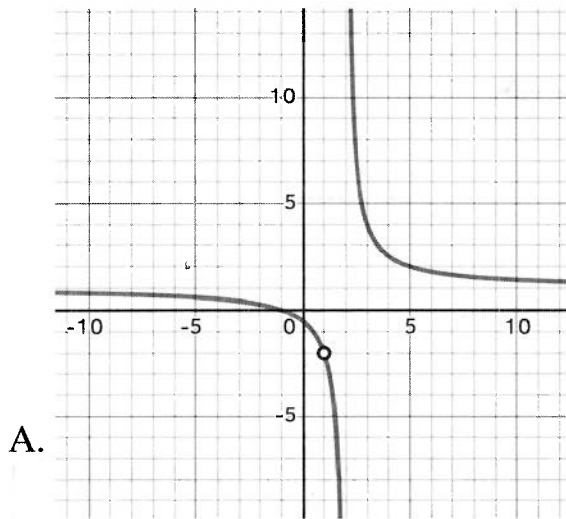

C $\frac{(x-2)(x+3)}{(x-1)(x+1)}$

B $\frac{x^2-1}{x-2}$

D $\frac{(x-1)(x+1)}{(x-2)(x+3)}$

A $\frac{x^2-1}{(x-2)(x-1)}$

NAME:

PID:

Midterm 2

Problem 8 Suppose you have an investment account worth \$20,000, which gains value at an annual rate of 10%, compounding once per year.

How much money will be in the account after 2 years?

$$20,000 + 0.1 \cdot 20,000 = 20,000 + 2000 = 22000$$

↑ amount
after 1 yr

$$22,000 + 0.1 \cdot 22,000 = 22,000 + 2200 \\ = \underline{\underline{24,200}} \text{ after 2 yrs}$$

Alternate solution

$$20000(1 + 0.1)^2 = 20000 \cdot (1.1)^2 = 20000 \cdot 1.21 \\ = 24200$$

Suppose now that the account gained value at the same annual rate but compounded at the end of each week (instead of each year). After 50 years, would the amount of money in the account... (circle one)

(a) Be greater than if it had been compounded annually

(b) Be the same as if it had been compounded annually

(c) Be less than if it had been compounded annually

